

SOFAR

# USER MANUAL

**BTS E5~20-DS5**

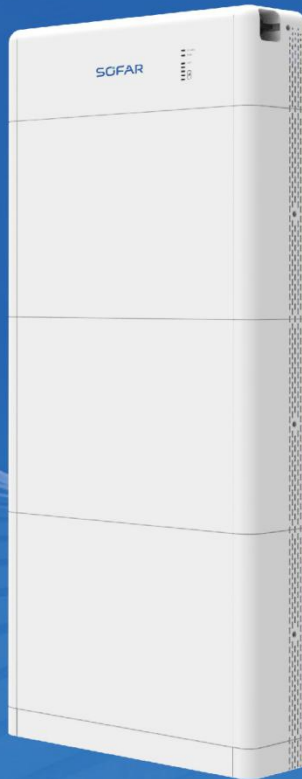

Shenzhen SOFARSOLAR Co., Ltd.



# Contents

Preface.....	3
<b>1. Basic Safety Information.....</b>	<b>6</b>
<b>1.1 Requirement for Installation and Maintenance.....</b>	<b>6</b>
1.2 Description of safety information symbols.....	9
<b>2. Product Introduction.....</b>	<b>12</b>
2.1 Product overview.....	12
2.2 Product Model Description.....	13
2.3 Product Appearance.....	15
<b>2.4 Indicator lights description.....</b>	<b>17</b>
2.5 Product label.....	18
2.6 System capacity expansion description.....	20
<b>3. Product Installation.....</b>	<b>21</b>
3.1 Checking Before Installation.....	21
3.2 Preparation for Installation Tools.....	22
3.3 Installation environment.....	23
3.4 Installation Space.....	24
3.5 Battery system installation.....	25
<b>4. Electrical Connection.....</b>	<b>29</b>
4.1 Preparation of Connection Cables.....	30
4.2 Electrical Connection for Internal System.....	30
<b>4.2.1 Protection grounding cable connection.....</b>	<b>30</b>
<b>4.2.2 Power cables connection.....</b>	<b>31</b>
<b>4.2.3 Communication cable connection.....</b>	<b>32</b>
4.3 External Electrical Connection.....	35
<b>4.3.1 External Electrical Connection.....</b>	<b>35</b>
<b>4.3.2 External ground Connection of the PGND cable.....</b>	<b>36</b>
<b>4.3.3 DC power cable installation.....</b>	<b>38</b>
<b>4.3.4 BMS communication cable installation.....</b>	<b>40</b>
4.4 Battery parallel installation.....	41
4.5 Fuse replacement.....	42

4.6	Install the protective cover.....	43
5.	Commissioning.....	45
5.1	Double Check.....	45
5.2	Electrify for the First Time (Important) .....	45
5.3	Battery Parameter Settings.....	45
5.4	Software Update.....	47
5.5	Battery Powered Off.....	48
6.	Trouble shooting and maintenance.....	49
6.1	<b>Troubleshooting</b> .....	49
6.2	<b>Daily Maintenance</b> .....	54
6.3	<b>Battery Module Storage Requirements and Power Supply</b> .....	54
7.	DataSheet.....	56
8.	Manufacturer's Warranty and Liability Terms.....	60

# Preface

## **Notice**

The purchased products, services and features are governed by the commercial contract made by the Company. All or part of the products and features described in this document may not be within the purchase scope. Except as otherwise agreed herein, no representations or warranties, express or implied, are made as to the contents of this document.

## **Save this Instruction**

This manual must be considered as an integral part of the equipment. Customer can print the electronic version to hard copy and keeping properly for future reference. Anyone who operates the device at any time must operate in accordance with the requirements of this manual.

## **Copyright Declaration**

The copyright of this manual belongs to Shenzhen SOFARSOLAR Co., Ltd. Any corporation or individual should not plagiarize, partially cope or fully copy (including software, etc.), not allow to duplication and publishment in any form and any way. All rights reserved, SOFAR reserves the right of final interpretation. This manual subject to modify according to user's or customer's feedback. Please check our website at <http://www.sofarsolar.com> for lasted version.

## Document Updates

V3.0 2023-10-27

## Outline

It describes the assembly, installation, commissioning, maintenance and failure of the product. Please read it carefully before operating.

## Scope of Validity

This product user manual describes the installation, electrical connection, debugging, maintenance and troubleshooting of BTS series intelligent battery system. The series includes the following models:

BTS	BTS	BTS	BTS
E5-DS5	E10-DS5	E15-DS5	E20-DS5





## Target Group

This document is intended for professional electrical engineers who are responsible for battery installation and commissioning, including technical support engineers, system engineers, and electrical engineers.

## Symbols Used

In order to ensure the personal and property safety of users when using BTS series intelligent battery system, as well as the efficient use of this product, the manual provides relevant safe operation information and highlights it with corresponding symbols. These stressed messages must be fully understood and

absolutely adhered to avoid personal injury and property damage. The symbols used in this manual are listed below.

	<p>“Danger”indicates a hazardous situation which, if not avoided, will result in death or serious injury.</p>
<p><b>Danger</b></p>	
	<p>“Warning”indicates a hazardous situation which, if not avoided, could result in death or serious injury.</p>
<p><b>Warning</b></p>	
	<p>“Caution”indicates a hazardous situation which, if not avoided, could result in minor or moderate injury.</p>
<p><b>Caution</b></p>	
	<p>“Attention”indicates there are potential risks, if fail to prevent, may lead to equipment cannot normally or property damage.</p>
<p><b>Attention</b></p>	
	<p>“Note”provides additional information and tips that are valuable for the optimal operation of the product, will help you to solve a problem or save your time.</p>
<p><b>Note</b></p>	

# 1. Basic Safety Information

Please read the instruction carefully. Faulty operation may cause serious injury or death.

	If you have any question or problem when you read the following information, please contact Shenzhen SOFARSOLAR CO., Ltd.
<b>Note</b>	

## 1.1 Requirement for Installation and Maintenance

The installation of BTS series intelligent battery system must be in full compliance with national and local laws and regulations.

Read and understand all instructions contained in this manual and familiarize yourself with safety symbols before installing and commissioning the device.

For any maintenance or repair, please contact the nearest authorized repair center. For information about the nearest authorization center, contact your reseller. Do not repair by yourself, which may cause personal injury or property injury.

Before installing and maintaining the device, disconnect the device from the external device using the DC switch. Otherwise, the high voltage may cause serious injury.

SOFAR will not be responsible for any personal injury or property injury caused by improper use.



### Installation and maintenance personnel requirements

The personnel responsible for installation and maintenance of the equipment for the first voyage must first receive strict training, understand various safety precautions and master correct operation methods.

- Only qualified professionals or trained personnel are allowed to install, operate, and maintain the device.
- Only qualified professionals are allowed to remove safety facilities and repair devices.
- The personnel, including the operators, trained personnel, and professional personnel, who operate the equipment should have the special operation qualification required by the local state, such as the qualification of high voltage operation, height climbing, and special equipment operation.
- Only professional or authorized personnel can replace equipment or components (including software).

	<ul style="list-style-type: none"> <li>➤ Professional personnel: those who have the training or operation experience of equipment and are able to understand the potential sources and magnitude of hazards in the process of equipment installation, operation and maintenance.</li> <li>➤ Trained personnel: personnel who have received the appropriate technical training and have the necessary experience are aware of the risks that may be posed to them in performing a certain operation and can take measures to minimize the risks to themselves or other personnel.</li> <li>➤ Operators: operators who may have</li> </ul>
<p><b>Note</b></p>	

	access to the equipment except trained and professional personnel.
--	--

### **Assembly Condition**

Assemble the BTS intelligent battery system as detailed in the following sections of this manual. Place the battery in a position that can be fixed on the edge and ensure that it is placed vertically. A suitable place for installation of electrical equipment should be selected to ensure sufficient space for fire escape for maintenance in case of failure. Maintain proper ventilation to ensure adequate air circulation for cooling, and air humidity is recommended to be less than <90% during assembly.

### **Transportation Requirement**

The Batteries are in the good electrical and physical condition when it ship out from factory. During transport, battery module must be placed in its original package or other proper package. Transportation company should responsible for any damage during transport period. Please check the battery thoroughly when taking delivery. If you find any packing problems that may cause the damage of inverter or any visible damage, please notice the responsible transportation company immediately. You can ask your installer or SOFAR for help is necessary.





This product contains battery module through UN38.3, belongs to the ninth category of dangerous goods. Therefore, loading and unloading must comply with local laws and regulations and industry standards during transportation. Rough loading and unloading may cause short circuit or damage to batteries in

containers, which may result in battery leakage, breakage, explosion, or fire.

### Requirement During the Transportation

- Shipping complies with the IMDG CODE and the International Maritime Dangerous Goods CODE.
- For land transportation, comply with ADR or JT T617 shipping requirements
- Meet the regulatory requirements of the transport regulatory authorities of the country of origin, route and destination.
- Comply with international regulations for the transport of dangerous goods and the supervision requirements of the corresponding national transport regulatory authorities.





## 1.2 Description of safety information symbols

	<p>High voltage of battery may be harmful to health!</p> <p>Only certified engineer can operate the product; Juveniles, Disable, should not use this product;</p> <p>Keep this product out of the reach of children;</p>
<p><b>Danger</b></p>	
	<p>Caution of burn injuries due to hot enclosure!</p> <p>Only touch the screen and pressing key of the product while it is working</p>
<p><b>Caution</b></p>	
	<p>Batteries should be grounded in accordance to the requirements of the local electrical grid company</p>
<p><b>Attention</b></p>	
	<p>To ensure that the battery is used in the equipment system authorized by SOFAR, and</p>

<b>Warning</b>	the battery is damaged or other losses caused by illegal use or unauthorized use of the equipment by SOFAR. SOFAR has the right not to do warranty, not to bear joint liability.
----------------	--





### Sings on the battery module

The battery module carries a number of safety related labels. Make sure to read and understand the labels carefully before installing the device.

Symbols	Name	Explanation
	This is a residual voltage in the battery module!	There is a high voltage,when the battery is powered on. After the battery is powered off, the internal capacitor is still charged, operator should wait for 5 minutes to ensure the capacitor is completely discharged.
	Caution of high voltage and electric shock	The battery module operates at high voltages. Prior to performing any work on the product, disconnect the product from voltage sources. All work on the product must be carried out by qualified persons only.
	Caution of hot surface	The battery module can get hot during operation. Avoid contact during operation.
	Grounding Terminal	Connect the battery module to the ground bar for grounding protection
	Observe the documentation	Read all documentation supplied with the product before install

## Sings on the battery distribution unit

The battery distribution unit carries a number of safety related labels. Make sure to read and understand the labels carefully before installing the device.

Symbols	Name	Explanation
	This is a residual voltage in the battery module!	There is a high voltage,when the battery is powered on. After the battery is powered off, the internal capacitor is still charged, operator should wait for 5 minutes to ensure the capacitor is completely discharged.
	Caution of high voltage and electric shock	The battery module operates at high voltages. Prior to performing any work on the product, disconnect the product from voltage sources. All work on the product must be carried out by qualified persons only.
	Caution of hot surface	The battery module can get hot during operation. Avoid contact during operation.
	Grounding Terminal	Connect the battery module to the ground bar for grounding protection
	Observe the documentation	Read all documentation supplied with the product before install

## 2. Product Introduction

### 2.1 Product overview

BTS series intelligent battery system is mainly composed of battery module and battery distribution unit. The input and output voltages are high DC voltage. The system adopts modular design and stacked installation method. The capacity can be flexibly configured based on actual requirements. The capacity ranges is 5.12kWh ~ 40.96kWh.

#### The main features are as follows:

- Full modular design, easy to install and transport;
- Current balance between battery modules, higher battery available capacity;
- Capacity Expansion by Stages;
- Low power consumption of battery;
- One key activate/shutdown.

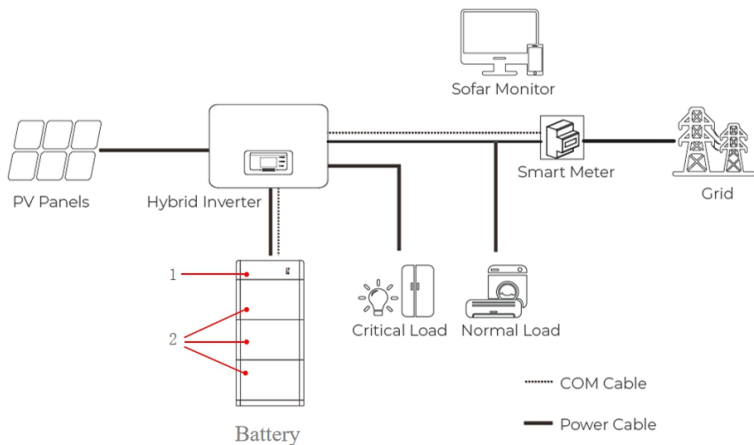

Figure.2-1 BTS series application principle diagram

Table 2-1 Battery module model demonstration

No	Definition
1	BTS 5K-BDU
2	BTS 5K

## 2.2 Product Model Description

**Battery module:**

BTS   5K  
 ①            ②

Figure 2-2 Battery module model identifiers

Table 2-2 Battery module model demonstration

Identifiers	Meaning	Specification
①	Product series name	SOFAR BTS series battery module name
②	Battery module energy grade	5K: Battery nominal module energy is 5.12kWh

**Battery distribution unit:**

BTS   5K   BDU  
 ①            ②            ③

Figure 2-3 Battery distribution unit model identifiers

Table 2-3 Battery distribution unit model demonstration

Identifiers	Meaning	Specification
-------------	---------	---------------

①	Product series name	SOFAR BTS series -battery module name
②	Battery module energy grade	5K: Battery module nominal energy is 5.12kWh
③	System Unit	BDU: Battery distribution unit

**Battery system:**

BTS   E5-DS5  
 ①            ②            ③

Figure 2-4 Battery system model identifiers

Table 2-4 Battery system model demonstration

Identifiers	Meaning	Specification
①	Product series name	SOFAR BTS series battery module name
②	Energy grade	E5: Battery total energy is 5.12kWh E10: Battery total energy is 10.24kWh E15: Battery total energy is 15.36kWh E20: Battery total energy is 20.48kWh



③	Battery module mode	DS5: Battery module is BTS 5K
---	---------------------	-------------------------------

### 2.3 Product Appearance

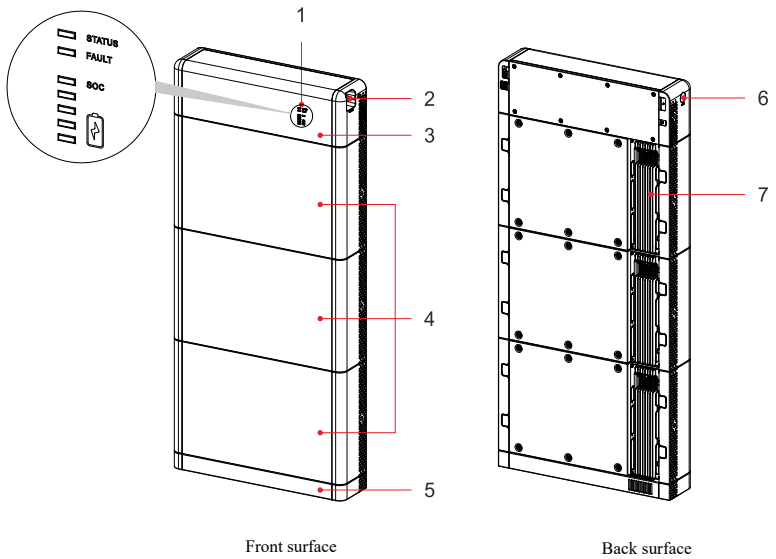

Figure 2-5 System appearance diagram

Table 2-5 System appearance definition

No	Definition	No	Definition
1	Indicator light	5	Base
2	DC switch	6	Black startup switch
3	Battery distribution unit	7	Heat sink
4	Battery module		

#### Battery distribution unit:

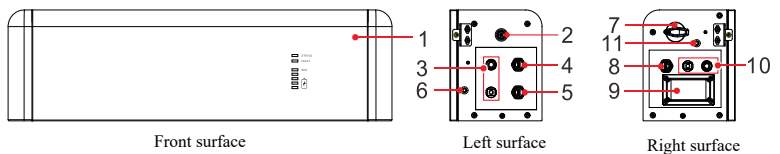

Figure.2-6 Schematic diagram of battery power distribution unit ports

Table 2-6 Interface definition of battery power distribution unit

No	Definition	No	Definition
1	Battery distribution unit	7	DC switch
2	Black startup switch	8	BDU communication output ( COM-OUT )
3	Battery input ( BAT IN )	9	Fuse
4	BDU cascading communication port(Link)	10	Battery output ( BAT Out )
5	BDU communication input ( COM-IN )	11	Grounding hole
6	Grounding hole		

**Battery module port:**

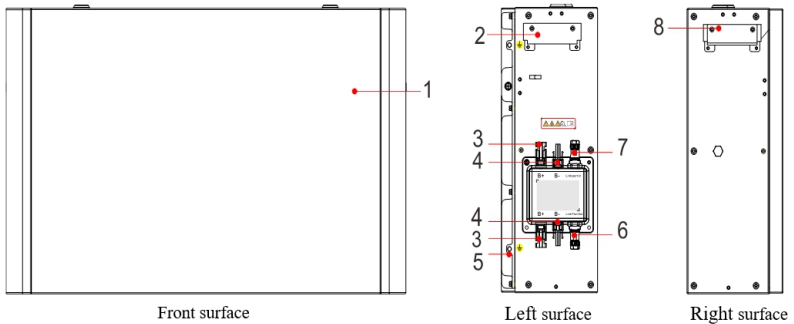

Figure.2-7 Battery module port diagram

Table 2-7 Battery module interface definition

No	Definition	No	Definition
1	Battery module	5	Grounding hole
2	Left side handle	6	Communication output ( Link Port Out )

3	Output terminal B+	7	Communication input ( Link Port In )
4	Output terminal B-	8	Right side handle

## 2.4 Indicator lights description

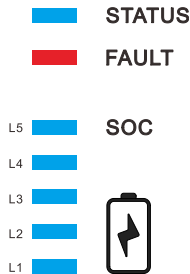

Figure.2-8 Indicator diagram

### Normal status indicator light:

Table 2-8. Normal status indicator light definition

Status	Status light	Alarm light	SOC light					
			L1	L2	L3	L4	L5	
Shutdown								
Standby	★ (t=1 s)		Display according to the battery SOC value					
Updating	★ (t=1 s)							
Charge	●							
Discharge	●							

### SOC Indicator light definition:

Table 2-9 SOC indicator light definition while charging

SOC value	SOC light				
	L1	L2	L3	L4	L5
0%~4%					
5%~19%	★ (t=1 s)				
20%~39%	●	★			

		(t=1s)			
40%~59%	●	●	★ (t=1s)		
60%~79%	●	●	●	★ (t=1s)	
80%~100%	●	●	●	●	★ (t=1s)

Table 2-10 SOC indicator light definition while discharging

SOC Value	SOC light				
	L1	L2	L3	L4	L5
0%~4%					
5%~19%	●				
20%~39%	●	●			
40%~59%	●	●	●		
60%~79%	●	●	●	●	
80%~100%	●	●	●	●	●

## 2.5 Product label

**Battery distribution unit:**







 BTS Intelligent Energy Storage	
System Model/ Nominal Energy/ Rated Power/ Max. Charging Current/ Max. Discharging Current	<input type="checkbox"/> BTS E5-DS5/5.12kWh/2.5kW/6A/7.5A <input type="checkbox"/> BTS E10-DS5/10.24kWh/5kW/12A/15A <input type="checkbox"/> BTS E15-DS5/15.36kWh/7.5kW/18A/22.5A <input type="checkbox"/> BTS E20-DS5/20.48kWh/10kW/24A/30A
Charge&Discharge Voltage Range	350~435Vdc
Enclosure Type	IP65
Protective Class	Class I
Guangdong Sofar Smart Solar Technology Co., Ltd.   Made in China No.1,Dongsheng North Road,Chenjiang Street,Zhongkai High-tech Zone,Huizhou City(One license multiple addresses)   	

Figure.2-9 Battery distribution unit label

**Battery module :**





 Energy Storage Battery	
<b>Model:</b>	<b>BTS 5K</b>
Battery Type: LFP	Battery Interface: Isolated
Total Energy: 5120Wh	Enclosure Type: IP65
Max Output Current: 7.5A	Weight: 50 kg
Input/Output: 300-435Vdc; 7A; 2.5kW	
Operating Temperature Range: -10 ~ +50°C	
Guangdong Sofar Smart Solar Technology Co., Ltd. 3/F.-4/F., Building No.4, Plant of Area D, Qiaosheng Industrial Park, Lizhen Road, Panli Village, LilinTown, Zhongkai High-tech Zone, Huizhou City,Guangdong, China	Made in China   

Figure.2-10 Battery module label

	The picture is for reference only, please refer to the actual product.
<b>Note</b>	

## 2.6 System capacity expansion description

The BTS series intelligent battery system supports capacity expansion. Up to four battery modules are managed by one BDU and supports up two BDU in a communication network. Each BDU has independent output. The expandable capacity of the single-cluster battery system ranges is 5.12kWh ~ 20.48kWh.

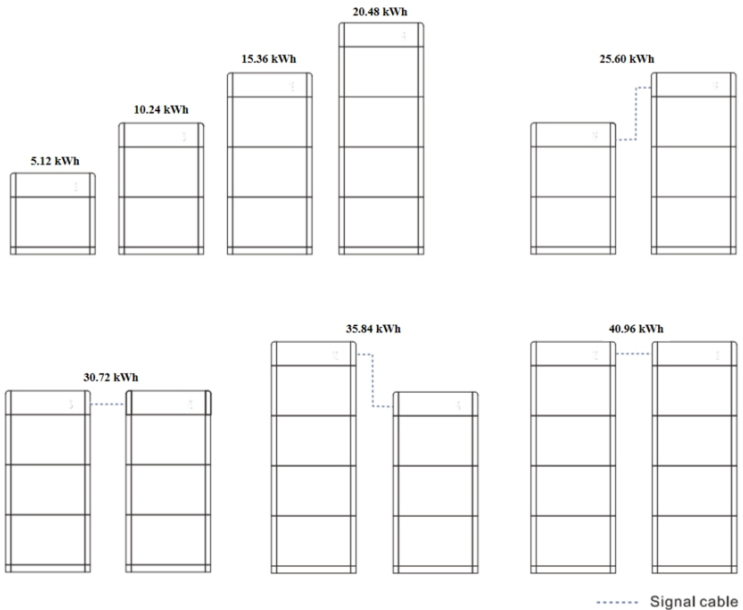





Figure. 2-11 Schematic diagram of system capacity expansion

## 3. Product Installation

### Announcements

 <b>Danger</b>	Do not install batteries on flammable materials. Do not install batteries in places where flammable or explosive materials are stored.
 <b>Careful</b>	The enclosures and fins are very hot when battery modules is operated, so do not install battery systems where you may inadvertently come into contact with them.
 <b>Attention</b>	Consider the weight of the battery module when transporting and moving it. Select suitable mounting position and surface. At least two persons are required to install battery modules.

### 3.1 Checking Before Installation

#### Checking Outer Packing Materials

Packing materials and parts can be damaged in transit. Therefore, check the packing materials of battery modules and BDU before installing them. Check whether the outer packing materials are damaged, such as holes and cracks. If any damage is found, please do not open the package and contact the distributor as soon as possible. It is recommended that you remove packing materials within 24 hours before installation.

#### Checking packing list





After the battery modules and BDU are unpacked, check whether the packaging and accessories are intact. If any damage is found or any components are missing, contact the distributor.

	Please check the assembly list in the box.
<b>Note</b>	



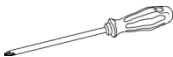
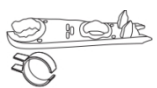
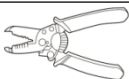

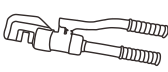

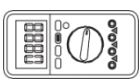
### 3.2 Preparation for Installation Tools

Prepare tools for installation and electrical connections.

Table 3-1 Tools required for installation and electrical connections

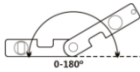
NO	Tool	Model	Function
1		Hammer drill Recommen d Drill @ Φ8mm	Used to drill holes on the wall.
2		4mm Screwdriver	Remove and install screws and wires
3		Removal Tool	Remove the output terminal of the battery module and BDU
4		Wire stripper	Used to peel cable
5		Sleeve	Install Fixed support rack
6		Crimping tools	Used to crimp OT connector
7		Heat gun	Used to coated with heat shrinkable casing
8		Multi meter	Check whether the cable connection is correct, the positive and negative terminals



			of the battery are correct, and the grounding is reliable
9		Marker	Mark signs
10		Measuring tape	Measure distance
11		Level	Ensure the rear panel is properly installed
12		ESD gloves	Installer wear when installing product
13		Safety goggles	Installer wear when drill holes
14		Mask	Installer wear when drill holes

### 3.3 Installation environment

Before installation, determine the proper position for installing the BTS series intelligent battery system.

**The following requirements must be met:**

- Choose a dry, clean, neat and convenient location for installation.
- Machine ambient temperature:  $-10^{\circ}\text{C}\sim 50^{\circ}\text{C}$ ;
- Relative humidity: 5-95% (non-condensing);
- The product should be placed in a well-ventilated place;
- There are no inflammable and explosive objects near the installation position of the product;
- The highest altitude of the installation environment is 4000m.

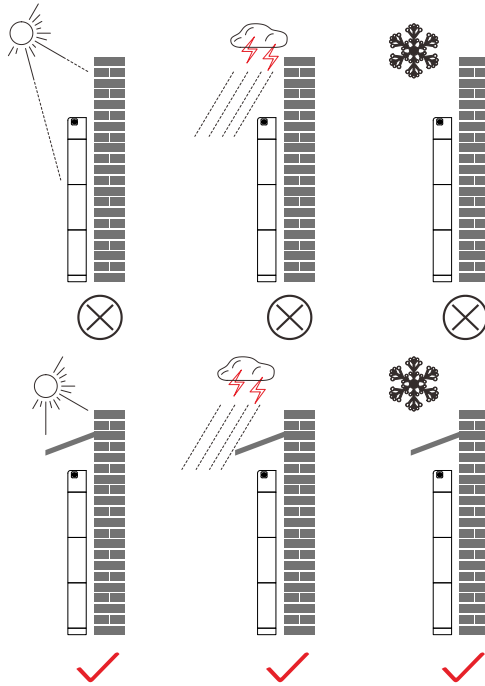

Figure. 3-1 Installation Environment Diagram

### 3.4 Installation Space

To ensure sufficient space for installation and heat dissipation, reserve enough space around the BTS series battery system. The requirements are as follows:

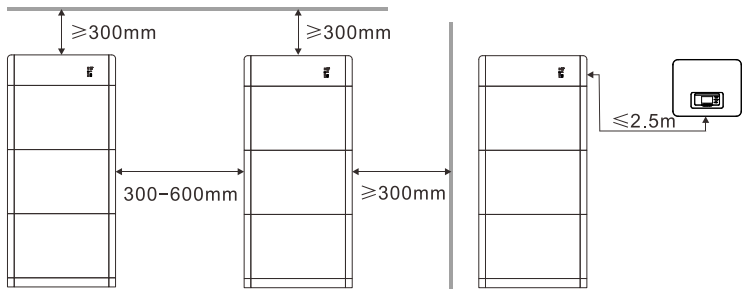

Figure. 3-2 Installation space diagram

### 3.5 Battery system installation

#### Installation dimensions diagram :

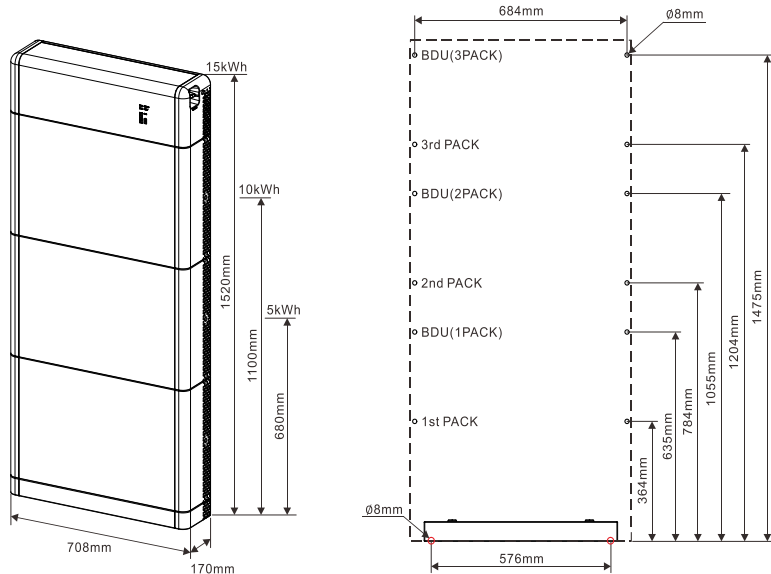



Figure. 3-3 System installation dimensions diagram

#### Base installation

##### Procedure:

1 ) Place the base against the wall and keep it 10 to 25 mm away from the wall surface. Use a level to adjust the hole position and mark the hole position with a marker.

	<p>Ensure that the distance between the base and the wall is 10-25mm. Otherwise, faults may occur.</p>
Attention	

2 ) Remove the base, drill holes using a hammer drill (  $\phi$  8mm, depth range 60-65 mm), and tighten expansion bolt to ensure that the base is securely installed.

3 ) Mark the holes for fixing the battery module and BDU

with a marker according to the dimensions shown in Figure 3-3.

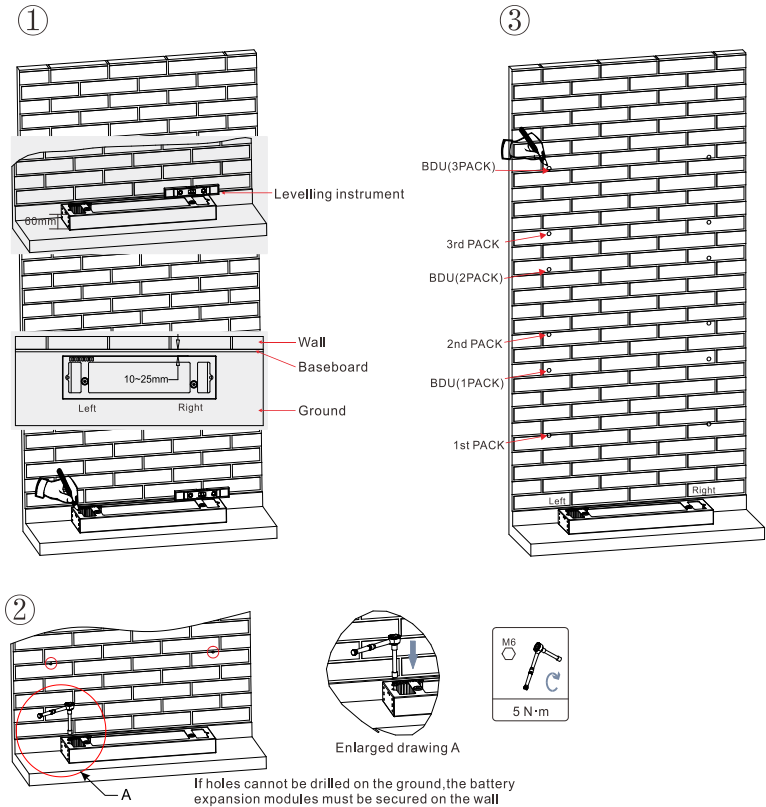

Figure. 3-4 base installation diagram

### Fixed installation between modules:

#### Procedure:

- 1 ) Place the first battery module on the base.
- 2 ) Install connectors on both sides and tighten the six screws with a cross screwdriver.
- 3 ) Install the remaining battery modules and BDU from bottom to top. (Before installing the next module, ensure that the screws on the side connectors of the previous module are firmly installed.)

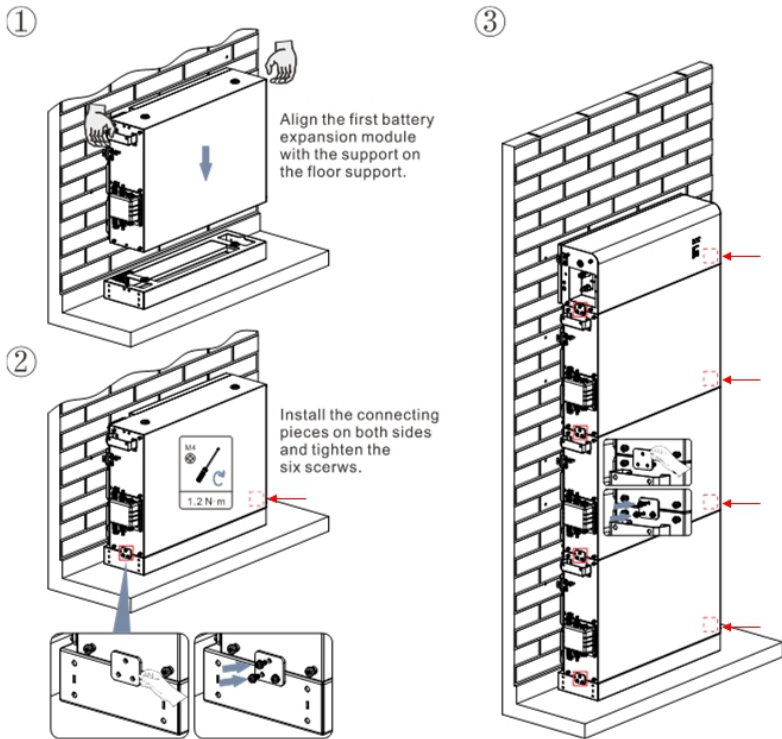

Figure. 3-5 Battery module installation diagram

### Anti-tip bracket installation:

#### Procedure:

1) Drill holes with a hammer drill ( $\phi$  8mm, depth range 60-65 mm). Reposition and drill the holes, if the original one has a large deviation.

2) Install the anti-tip bracket B on the wall, and fasten expansion bolt.

3) Adjust the anti-tip bracket A, make sure the holes are matched between anti-tip bracket A and anti-tip bracket B.

4) Connect and fix the anti-tip bracket A and anti-tip bracket B with M6\*16 screws.

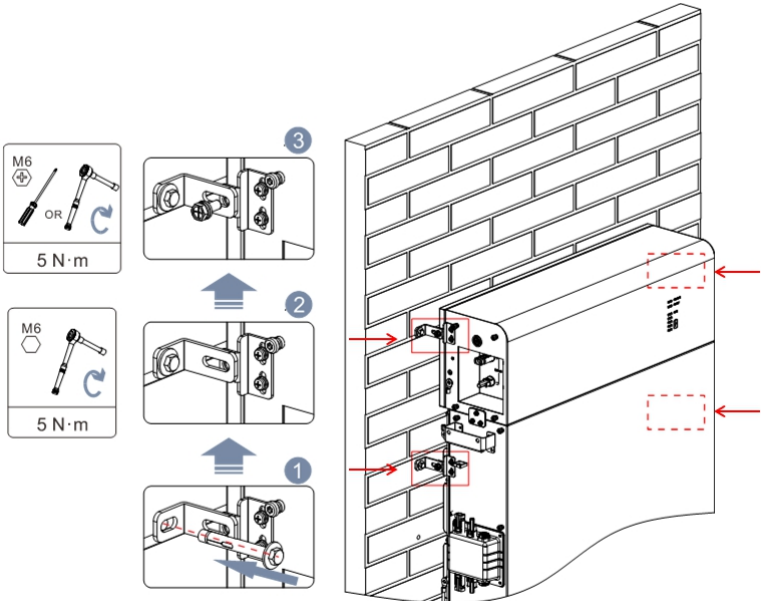





Figure. 3-6 Schematic diagram of wall fixing installation

## 4. Electrical Connection

This product is used for battery energy storage PV system.  
Equipment can be damaged if not used as intended.

	<p>Only professional electrical engineers can install and maintain batteries.</p>
<p><b>Attention</b></p>	<p>When making electrical connections, wear rubber gloves and protective clothing. When connecting the device electrically, you must first connect the protection ground cable. When removing a device, ensure that the PGND cable is removed at last.</p>
	<p>Before electrical connection, ensure that the DC switch of the BDU is OFF, the black start switch indicator is OFF, and the battery module has no output voltage.</p>
<p><b>Danger</b></p>	<p>Prepare a battery cable and ensure that the positive and negative output polarities of the battery are correct; otherwise, the device may be damaged.</p>
	<p>The equipment damage caused by operator's wrong wiring is not covered by the product warranty.</p>
<p><b>Note</b></p>	

## 4.1 Preparation of Connection Cables

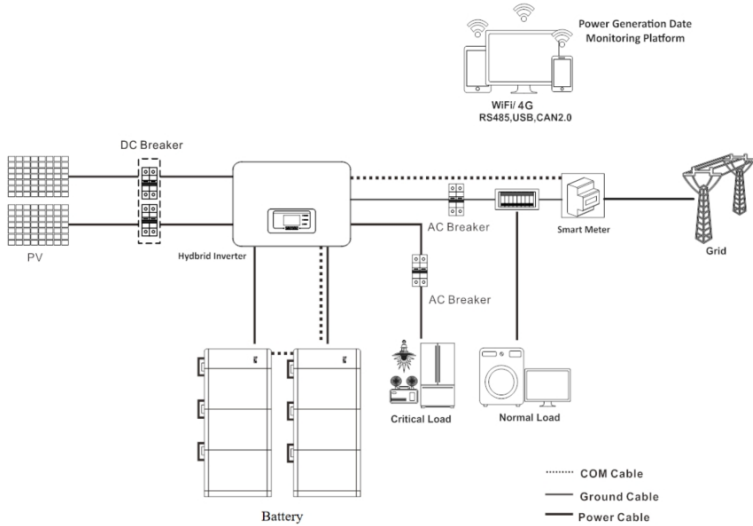

Figure 4-1 System connection diagram

Table 4-1 Cables prepared by customers

No	Cable	Recommended specifications
1	Power cable connect the BDU to inverter	UL10269 10AWG
2	Grounding cable	UL10269 8AWG

## 4.2 Electrical Connection for Internal System

### 4.2.1 Protection grounding cable connection

**Procedure:**

As shown in Figure 4-2, connect the grounding points between modules with protective grounding cables and ensure reliable connection of grounding cables.



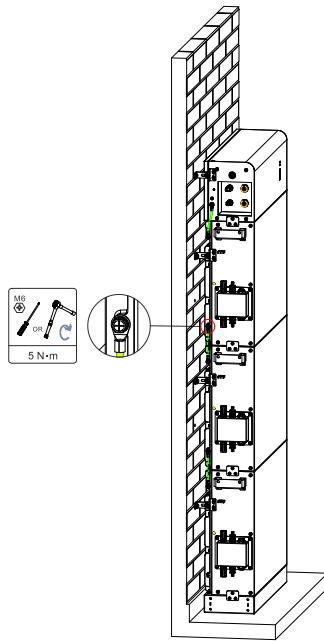

Figure. 4-2 Grounding cable connection diagram

## 4.2.2 Power cables connection

As shown in Figure 4-3, connect the BAT-IN power port on the BDU to the positive and negative terminals (B+ and B-) of the battery module using power cables. Connect the remaining battery modules from top to bottom in this way, and secure the cables using cable ties. Ensure that the cables are securely.

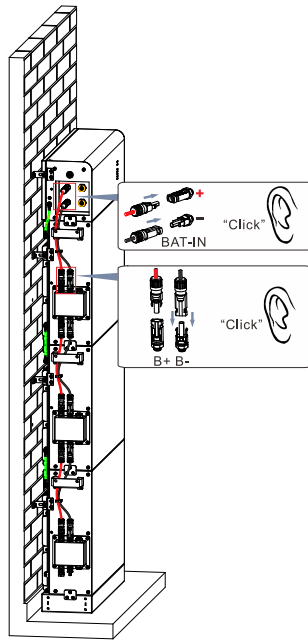

Figure. 4-3 Diagram of internal power cable connection

### 4.2.3 Communication cable connection

**Procedure:**

- 1) Connect the Link Port on the BDU to the Link Port In Port on the battery module by using a communications cable, lock the big nut and then the smaller nut clockwise to ensure a reliable connection, and connect the remaining battery modules from top to bottom, and secure them with cable ties.
- 2) Install a terminal resistor on the Link Port Out Port of the last battery module in the system, and lock the nut clockwise to ensure a firm and reliable connection (missing the terminal resistor may cause battery communication failure).

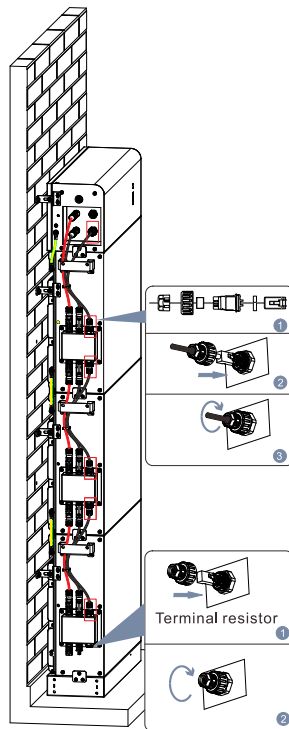

Figure. 4-4 Diagram of internal signal cable connection



### Note

For the safety of the battery system with a single cluster capacity of 20.48kWh, a base installation package is recommended and divided into two columns for installation. The following points should be paid attention to during electrical connection:

- 1) Connect the power cable. Connect the upper expansion terminal (B+,B-) on the uppermost battery module in one column (without the DBU) to the lower expansion terminal (B+,B-) on the bottom battery module in the other column.

- 2) For communications cable connections, connect the Link Port In on the uppermost battery module in one column (without the BDU) to the Link Port Out on the bottom battery module in the other column.

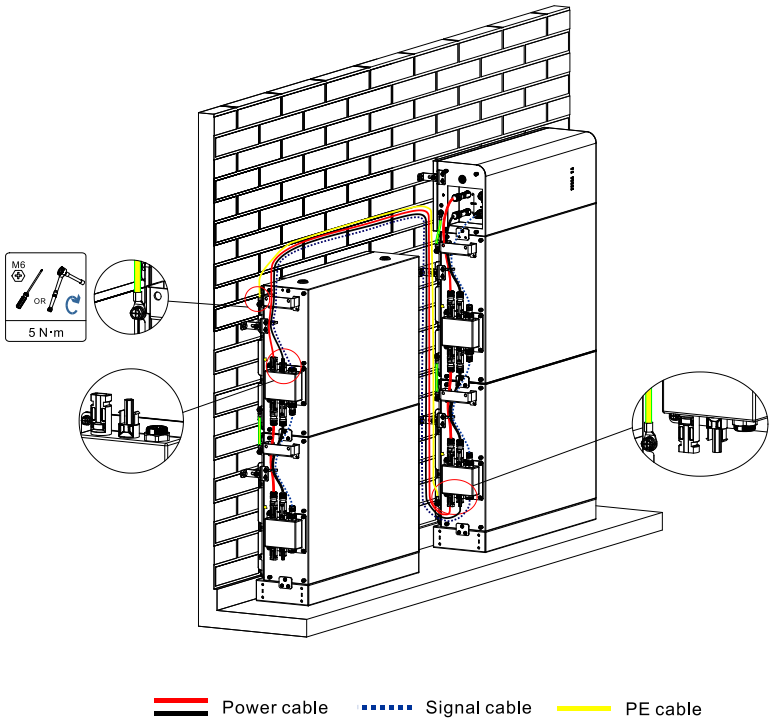

Figure. 4-5 Battery cluster installation diagram for 20kWh

## 4.3 External Electrical Connection

### 4.3.1 External Electrical Connection

The following is an example of the SOFAR storage inverter HYD 5/6/8/10/15/20KTL-3PH.

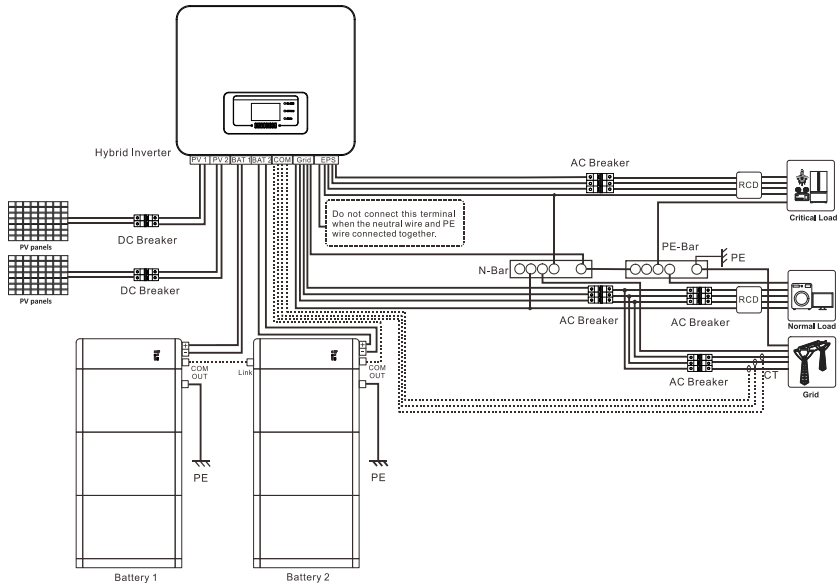



Figure. 4-6 System Connection Diagram

(For Australia, New Zealand and South Africa)

This is the schematic diagram of the application system where neutral line and ground line are connected together. For example, in Australia, New Zealand, South Africa and other countries, please follow the local safety requirements of the power grid.

	<p>According to Australian safety regulations, the neutral cables on the grid-connected side and EPS side must be connected together, otherwise the EPS function will not work.</p>
Note	

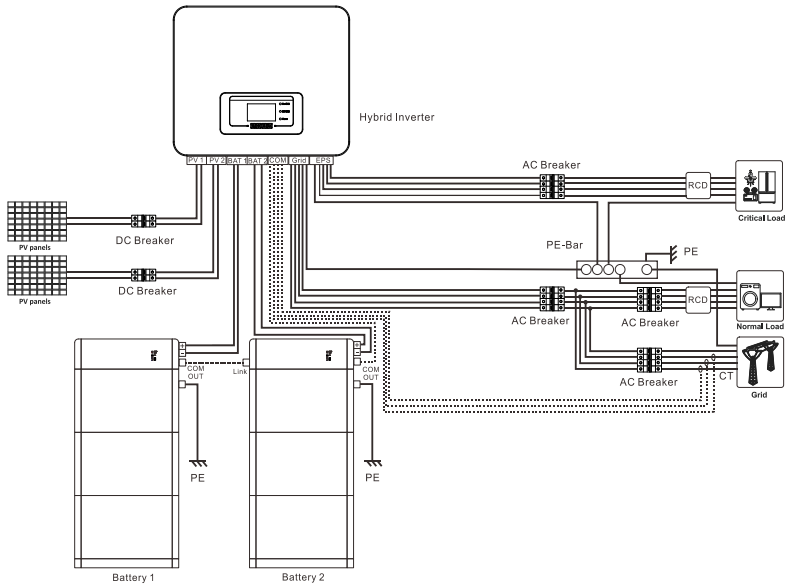



Figure. 4-7 System Connection Diagram

### 4.3.2 External ground Connection of the PGND cable

#### Step1: Crimp OT terminals

	<p>When stripping the cable, do not scratch the core of the cable. The grounding cable must be prepared by yourself. the grounding cable must be 8AWG and meet the requirements for outdoor use.</p> <p>The cavity formed after the conductor crimping plate of the OT terminal is fully covered with the cable core, and the cable core is tightly bound to the OT terminal. The pull-out force after the crimping complies with UL486A and UL310 standards.</p>
<p><b>Attention</b></p>	

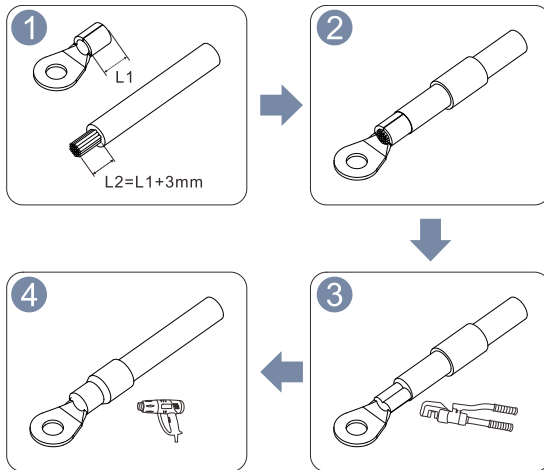

Figure. 4-8 Diagram of Crimping OT terminals

**Step 2:** As shown in Figure 4-8, install a protection ground cable at the ground terminal on the right of the BDU and connect it to the external ground protection point.

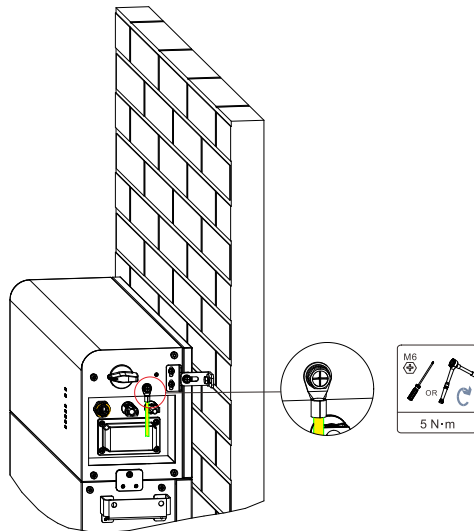

Figure. 4-9 Installation diagram of the protection ground cable

### 4.3.3 DC power cable installation

**Procedure:**

- 3) Select proper cable types and specifications based on Table 4-1. Remove cable connectors from positive and negative connectors. (It is suggested to use different colors to distinguish positive and negative poles).
- 4) Use a wire stripper to strip off the insulation layer of the positive and negative cables to a proper length. For details, see the peeling length diagram.4-10.
- 5) Insert the positive and negative cables with the insulation layer removed into the positive and negative metal terminals, and use crimping pliers to press the cable to the metal core contact of the terminal. Ensure that the cable is firmly crimped with the metal core.
- 6) The crimped positive and negative cables pass through the locking nut and are inserted into the corresponding plastic shell respectively until a clicking sound is heard, indicating that the metal core is clamped into place. Tighten the locking nut.

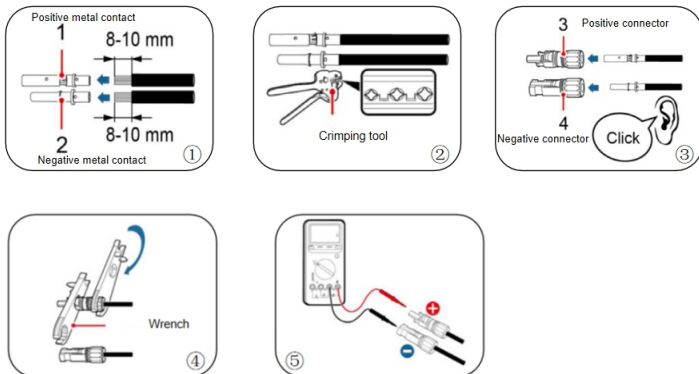

Figure. 4-10 Assembly diagram of battery DC terminal connector



To remove the BAT positive and negative connectors from the battery module or battery power distribution unit, insert the BAT positive and negative connectors into the bayonet and press them down to remove the DC connectors, as shown in Figure 4-11.

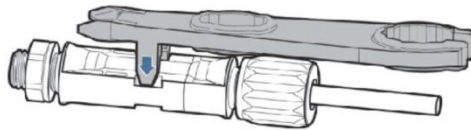

Figure. 4-11 Disconnect PV connectors

- 1) Use a multi meter to check the positive and negative poles .Connect the assembled DC terminal connector to the DC B+/B- input terminal on the battery power distribution unit, and connect the other end to the inverter side. Ensure that the connection is secure.

**Notice during installation:**

- It is not recommended to use armored cables for dc input cables to avoid cable breakage.
- Before assembling the DC connector, ensure that the polarity of the cable is correct and label the positive and negative cables
- After crimping the positive and negative metal terminals, pull back the DC input cable to ensure that the cable connection is secure.
- If the capacity of a cluster is higher than 15.36kWh, the batteries should be installed and connected in two columns.

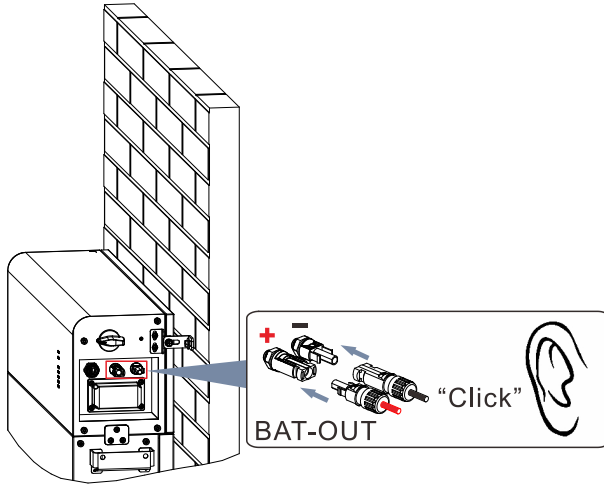

Figure. 4-12 Battery power cable Installation diagram

#### 4.3.4 BMS communication cable installation

Install the communication cable delivered with the accessories to the COM-OUT port of the battery distribution box, and connect the other end to the BMS communication ports CAN-H and CAN-L of the inverter respectively according to the label definition.

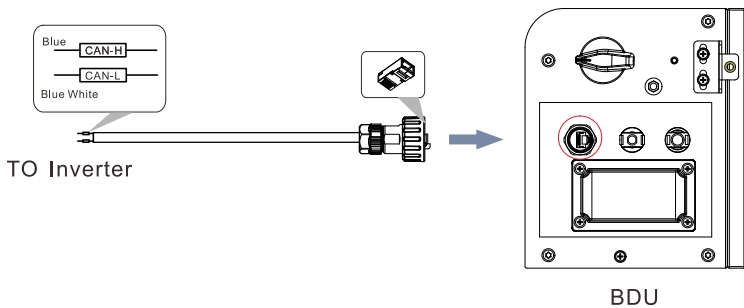

Figure. 4-13 BMS diagram of communication connection cable installation

The COM-OUT port pins of the battery distribution unit(BDU) are defined as follows:

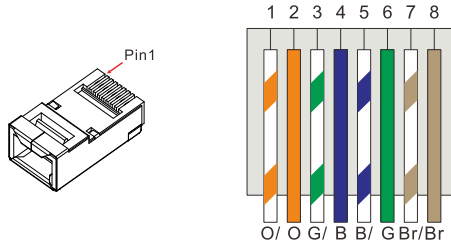

Figure. 4-14 COM-OUT port pin definition for battery distribution box

Table 4-2 Communication cable pin definition

Pin	Wire color	Definition
PIN1	Orange White	
PIN2	Orange	
PIN3	Green White	
PIN4	Blue	CAN-H
PIN5	Blue White	CAN-L
PIN6	Green	
PIN7	Brown White	
PIN8	Brown	

## 4.4 Battery parallel installation

The BTS series battery supports expansion up to two battery clusters. Power cables are connected to the inverter through the BDU, as shown in Figure 4-15. The battery cluster connected to the inverter is a slave, and the other cluster is a master. The parallel communication cable is connected from the COM-OUT port of the master to the Link port of the slaver.

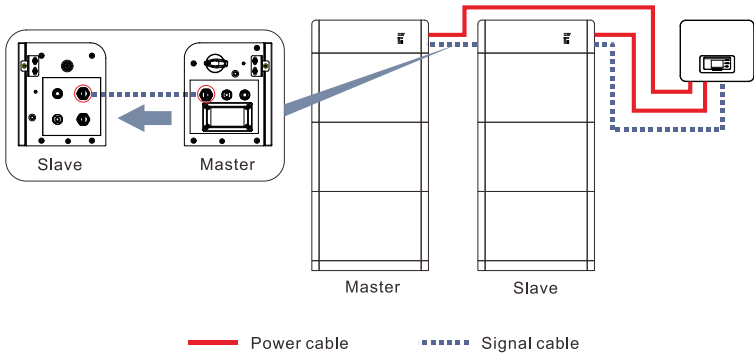

Figure. 4-15 Diagram of battery parallel installation

## 4.5 Fuse replacement

If the fuse of the battery distribution unit is damaged, replace it by a professional engineer

### Procedure:

- 1) To power OFF the battery system, set the switch of the battery distribution unit to OFF, turn OFF the indicator of the battery black start switch, and all the LED indicator of the battery distribution unit is OFF. To power OFF the system for five minutes, ensure that the remaining battery charges are discharged.
- 2) Use a cross screwdriver to loosen the screws on the fuses cover and remove the fuses cover.

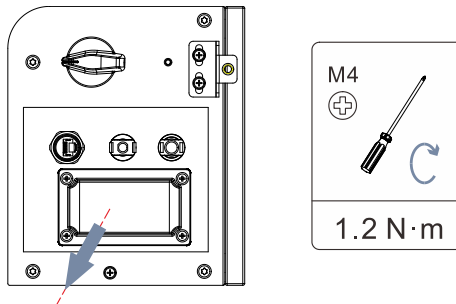

Figure. 4-16 Diagram of removing fuse outer cover

- 1) Open the fuse box backward, take out the damaged fuse, place a new fuse in the fuse slot, and close the fuse box until you hear a clicking sound, indicating that the fuse box is installed in place.

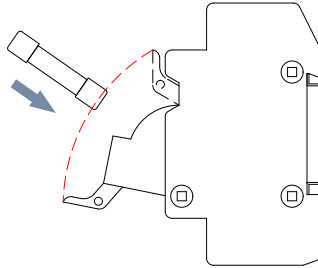

Figure. 4-17 diagram of replacing fuse

Table 4-3 Fuse model

No	Brand	Mode	Specification Requirements
1	SINO	RS309-MF-14C40A	Rated Voltage : 750Vdc Rated Current : 40A Package Dimensions : 51*14.3mm
2	BUSSMAN	FWP-40A14Fa	
3	FRZ	FRB-C14-63A	

## 4.6 Install the protective cover

After electrical connections are complete and cable connections are correct and reliable, install the external protective cover.

### Procedure:

- 1) Install protective covers on both sides of the base.
- 2) Install protective covers on both sides of the battery module or BDU.

3) Tighten the protective cover with screws.

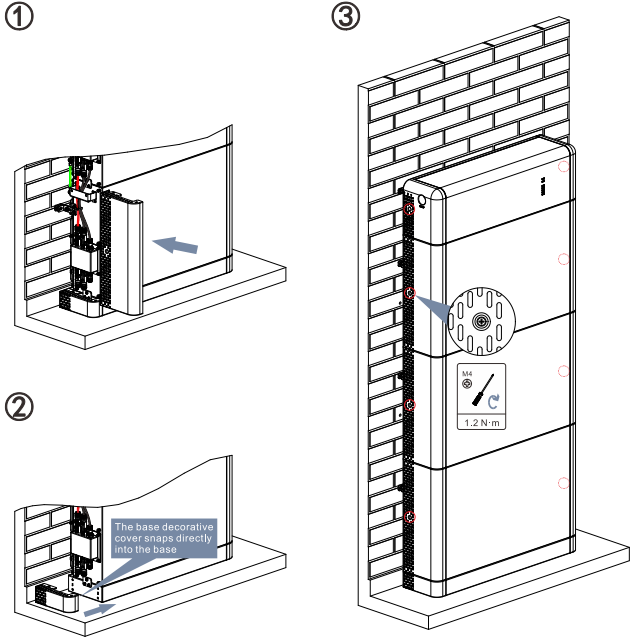

Figure. 4-18 Diagram of installing protective cover

## 5. Commissioning

### 5.1 Double Check

Please double check the following items before running:

- Battery module, BDU and the base should be completely fixed.
- Each BAT+/BAT- line is firmly connected, the polarity is correct, and the voltage is in line with the accessible range.
- The DC switch of the BDU is OFF, and the black start indicator is OFF.
- Ensure that the communication cable is firmly connected to the terminal resistor.
- Install sealing plugs on unused terminals or interfaces.
- Cable is arranged reasonably, and the cable is tidy and without damage.

### 5.2 Electrify for the First Time ( Important )

- 1) Set the DC switch of the BDU to ON.
- 2) Press the black start switch on the BDU to power on the battery for the first time. Observe the LED indicator on the BDU to check the running status.

### 5.3 Battery Parameter Settings

If the system uses SOFAR HYD series inverter, the battery parameters can be set as follows:

**Procedure:**

**Battery Parameter Settings**

1) Battery type settings:

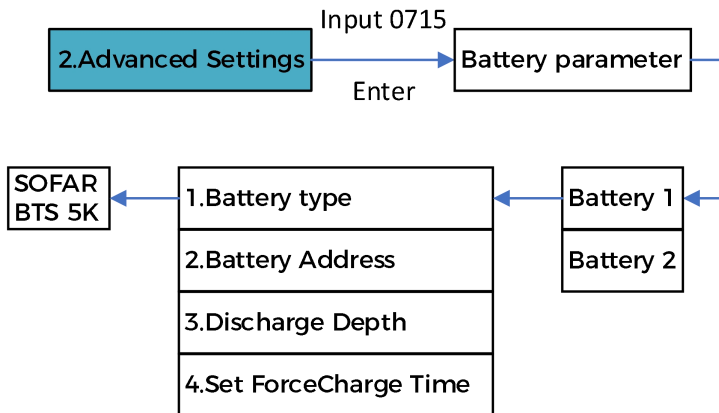

1) Set discharge depth: Set the following parameters as required:

- ① Discharge Depth: ② EPS Discharge Depth: ③ EPS Safety Buffer
- 2) Set force charge time ( The time difference is no less than 3 hours )
- 3) Save

	<p>If batteries are connected to both battery channels of the inverter, perform the preceding steps to set battery parameters for batteries 1 and 2.</p>
<b>Note</b>	

**Configures an address automatically**

After battery parameters are set, ensure that the system has reliable PV or utility power supply.

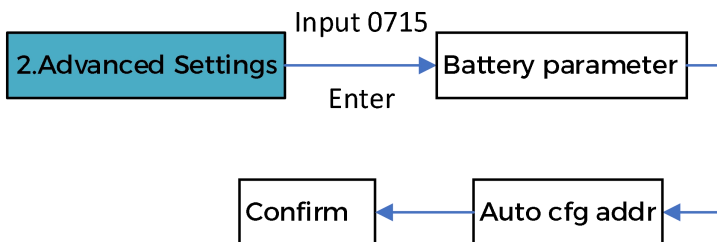



**Note**

- The online batteries quantity is displayed on the auto IP address configuration page. You can configure the IP address automatically only after comparing the connected batteries quantity with the actual quantity.
- The automatic configuration takes about 2 to 3 minutes.
- During the automatic address configuration, the corresponding PCU output is enabled or disabled. If the batteries quantity is incorrect, check the communications cable connection.

## 5.4 Software Update

The product can be upgraded through the software of SOFAR HYD series energy storage inverters to maximize the performance of the product and avoid the abnormal operation of the product caused by software bugs.

Before upgrading the software, check that the communication cables of the system and the DC power cables of the battery are properly connected, and ensure that the system has reliable power supply from utility or PV during the upgrade.

Procedure:

- 1) Insert the USB drive into the computer.
- 2) The upgrade file folder is named firmware. After receiving the upgrade file, decompress it and save it in a USB disk.
- 3) Insert the USB disk into the USB/Wifi interface of the energy storage inverter .
- 4) Set the DC switch of the battery distribution unit to "ON state", press the black start switch, and the energy storage inverter and battery start up and run.

- 5) Perform the following operations on the LCD of SOFAR HYD series energy storage inverter :

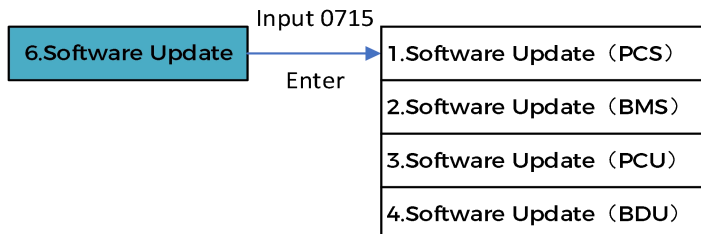

- 1) If an error message occurs, upgrade again. If this situation persists for several times, contact technical support for help.
- 2) After the upgrade is complete, you can view the current software version in System Info >> Software Version.

## 5.5 Battery Powered Off

- 1) Press the black start switch of BDU.
- 2) Set the DC switch of the BDU to OFF. All the LED indicators on the battery distribution box are OFF. After the system is powered OFF for five minutes, ensure that the remaining battery charges are discharged before performing maintenance.

## 6. Trouble shooting and maintenance

### 6.1 Troubleshooting

This section describes the potential errors for this product. Please read carefully for the following tips when doing the troubleshooting:

- 1) For details about the warning or error information displayed on the BDU status indicator, see 2.4 Description of Battery Status Indicators.
- 2) When the battery generates an alarm or error message, the alarm report is uploaded to the inverter. You can determine the cause of battery alarms or faults by viewing the inverter display or the monitoring system.

If the SOFAR HYD series hybrid energy storage inverter is used, you can view the recorded fault information by following the following steps: Press "Back" on the home screen to enter the main menu, select "Event List" and press "OK" to enter.

Fault information list of SOFAR HYD series energy storage inverter:

Table 6-1 Fault information list of the energy storage inverter

ID No.	Event Name	Solution
157	Lithium battery 1 communication is faulty	Check whether the communication cable or port of the battery module is faulty.
158	Lithium battery 2 communication is faulty	
159	Lithium battery 3 communication is faulty	
160	Lithium battery 4 communication is faulty	
177	BMS over voltage alarm	The lithium battery is

178	BMS under voltage alarm	faulty. Shut down the inverter and lithium battery. Wait for 5 minutes and start the inverter and lithium battery. Check whether the fault is rectified. If not, contact technical support.
179	BMS high temperature alarm	
180	BMS low temperature alarm	
181	BMS over current alarm	
182	BMS short circuit alarm	
183	BMS version inconsistency	Please contact technical support.
184	BMSCAN version inconsistency	
185	BMS CAN version is too low	
801	The charging soft start failed	Restart the battery. If the problem is not resolved, please contact technical support .
802	The discharging soft start failed	
807	PCU version inconsistency	Check whether the number of batteries is set correctly. If the setting is correct, please contact technical support to upgrade software.
808	Radiator 1 high temperature alarm	Please make sure the battery is installed in a cool well-ventilated place. If The battery is installed correctly,
809	Ambient high temperature alarm	

		please contact technical support .
813	Charging prohibition alarm	If the battery is almost fully, no action is required. Otherwise, please contact technical support .
814	Discharging prohibition alarm	If the battery is almost empty, no action is required. Otherwise, please contact technical support .
864	Over temperature protection of radiator 1	Power off and wait for 2 hours. If the problem is not solved, please contact technical support.
865	Over temperature protection of ambient temperature	
867	Can1 communication failure	If this fault occurs occasionally, wait a few minutes to see whether the problem is solved. If this fault occurs frequently, please contact technical support.
872	Bus software overvoltage	
873	Bus software undervoltage	
874	Battery software overvoltage	
875	Battery software undervoltage	
876	Battery software overcurrent	
879	Hardware overcurrent	
880	Permanent bus overvoltage	Restart the battery and wait for minutes. If the

881	Permanent battery undervoltage	problem is not resolved, please contact technical support.
882	Permanent Instant overcurrent	
883	Permanent hardware overcurrent	
894	Permanent battery activation failed	
895	Permanent bus reverse connection	Check whether the wiring is correct and restart the battery. If the problem is not resolved, please contact technical support.
896	Battery status error	Restart the battery. If the problem is not resolved, please contact technical support.
897	PWM mode error	
898	BMS version error	
899	BMS overvoltage and overcurrent fault	If this fault occurs occasionally, wait a few minutes to see whether the problem is solved. If this fault occurs frequently, please contact technical support.
900	Battery average overcurrent protection	
901	Average overload protection	
902	Bus software overcurrent	
903	Software CBC overcurrent protection	
904	Pack ID error	Restart the battery and wait for seconds. If the problem is not resolved, please contact technical

		support.
928	Battery reversal	Check whether the wiring is correct and restart the battery. If the problem is not resolved, please contact technical support.
929	Fusing failure	Restart the battery. If the problem is not resolved or occurs frequently, please contact technical support.

- 1) If the battery status indicator does not indicate any error, perform the following steps to check whether the current installation status meets the battery operating requirements:
- Is the battery installed in a clean, dry, well-ventilated location?
  - Check whether the battery DC switch is off?
  - Check whether the cable section and length meet requirements?
  - Is the wiring good?
  - Whether the configuration Settings are correct for the user's specific installation?
  - Whether the communication cable is correctly connected and is not damaged?

## 6.2 Daily Maintenance

	After the battery is powered off for 5 minutes, ensure that the capacitor inside the battery is discharged before maintenance.
<b>Attention</b>	

Batteries usually do not require maintenance or calibration, but ensure that the radiator is not covered with dust, dirt, etc.

### 1) Clean the battery module

Please clean the battery module with an air blower, a dry & soft cloth or a soft bristle brush. Do not clean the inverter with water, corrosive chemicals, detergent, etc.

### 2) Clean the heat sink

In order to ensure the normal function and long service life of the product, it is necessary to ensure that there is enough air flow space around the radiator at the rear of the product, and there is no material around the radiator that obstructs the air flow, such as dust or snow, must be removed. Clean the heat sink with compressed air, a soft cloth, or a soft brush. Do not use water, corrosive chemicals, cleaning agents, or strong detergents to clean the radiator.

## 6.3 Battery Module Storage Requirements and Power Supply

### Battery Module Storage Requirements:

- Environment temperature :  $-10^{\circ}\text{C}\sim 50^{\circ}\text{C}$ , Recommended storage temperature:  $25^{\circ}\text{C}\sim 35^{\circ}\text{C}$ .
- Storage relative humidity range: 5%~70%.
- Store in a dry, clean, and ventilated environment, away from direct sunlight.



- When storing the battery module, place it correctly. Do not put the battery module upside down or on its side.
- If the battery module is stored for a long time, replenish the power supply periodically. Battery module power supply requirements: the charging current is less than or equal to 7A, and the battery module needs to be charged to 50%SOC.

### Recharge Requirements During Normal Storage

When the battery is stored for a long time, you need to perform regular maintenance. If the storage time is close to that shown in the following table, arrange supplementary power supply in time.

Recharge conditions when in storage

Storage Environment Temperature	Relative Humidity of Storage Environment	Storage Time	SOC
< -10°C	/	Prohibit	/
-10°C ~ 25°C	5%~70%	≤12 months	30%≤SOC≤60%
25°C ~ 35°C	5%~70%	≤6 months	30%≤SOC≤60%
35°C ~ 45°C	5%~70%	≤3 months	30%≤SOC≤60%
> 45°C	/	Prohibit	/



### Recharge Requirements When Over Discharged

Recharge the battery within the time range specified in the following table (90%DOD). Otherwise, the over discharged battery module will be damaged.

Recharge conditions when battery is over discharged

Storage Environment Temperature	Storage Time	SOC
-10°C ~ 25°C	≤15 days	/
25°C ~ 45°C	≤7 days	30%≤SOC≤60%
-10°C ~ 45°C	≤12 hours	/

## 7. DataSheet

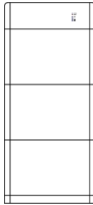
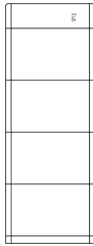
Model	BTS E5-DS5	BTS E10-DS5	BTS E15-DS5	BTS E20-DS5
System Schematic				
Battery Type[1]	LFP			
Battery Distribution Unit	BTS 5K-BDU			
Number of Battery Distribution Unit	1			
Battery Module	BTS 5K			
Number of Battery Modules	1	2	3	4
Battery Total Energy[2]	5.12kWh	10.24kWh	15.36kWh	20.48kWh
Rated Capacity	100Ah	200Ah	300Ah	400Ah
Rated Power	2.5kW	5kW	7.5kW	10kW
Nominal Voltage	400 Vd.c.			

Operating Voltage Range	350-435 Vd.c.			
Max. Charging Current	6A	12A	18A	24A
Max. Discharging Current	7.5A	15A	22.5A	30A
<b>General parameters</b>				
Display	LED			
Communication	CAN			
Dimension(W *H*D)	708*680*170 mm	708*1100*170 mm	708*1520*170 mm	708*170*1940 mm
Weight	59kg	110kg	161kg	212kg
Enclosure Type	IP65			
Cooling	Natural			
Operating Temperature Range[3]	Charge: 0° C to +50° C / Discharge: -10° C to +50° C			
Humidity	5~95%			
Installation	Floor stand			
Max. Operating Altitude[4]	4000m			
Noise Emission[5]	< 30dB			
<b>Battery module[6]</b>				
Model	BTS 5K			

Battery Module Energy	5.12kWh
Nominal Voltage	400 Vd.c.
Rated Power	2.5kW
Dimensions(W*H*D)	708*420*170 mm
Weight	50kg
<b>Battery distribution unit</b>	
Model	BTS 5K-BDU
Operating Voltage Range	350-435 Vd.c.
Maximum Current	30A
Number of BTS 5K	1-4
Protective Class	Class I
Enclosure Type	IP65
Dimension(W *D*H)	708*170*200mm
Weight	7.5kg
<b>Ordering and deliverable part</b>	
Product Ordering Model[7]	BTS 5K, BTS 5K-BDU

[1 ]Rechargeable Li-ion Battery system.

[2]Test conditions:0.2C charge/discharge at 25°C,100%DOD.

[3]Refer to the temperature derating curve.

[4]If the altitude is >2000m, derating operation is required, refer to the derating curve.

[5]Noise level (typical): < 30 dB(A) @1 m, 30° C, stable and rated power conditions.

[6]The internal battery pack is 51.2V, 100Ah.

[7]Storage system is ordered and delivered in the form of power module and battery module separately with corresponding quantity.

## 8. Manufacturer's Warranty and Liability

### Terms

#### **Warranty period**

Warranty period and calculation method of SOFAR battery products refer to the Quality Assurance Agreement of SOFAR BTS Series Intelligent lithium battery System.

#### **Extended warranty period**

If the purchased battery exceeds the warranty period stipulated in the Warranty Agreement of SOFAR BTS Series Intelligent lithium battery System, the customer can apply for the extended warranty period by providing the serial number of the product to the sales team of the company, and the Company has the right to reject the purchase application for the extended warranty period that does not meet the requirements.

If the original buyer wants to apply for the extended warranty service, please contact the sales team of Shenzhen SOFARSOLAR Co., LTD to purchase the products that exceed the extended warranty period but have not passed the warranty period stipulated in the Warranty Agreement of SOFAR BTS Series Intelligent lithium battery System, the original buyer shall bear different extended premiums.

Upon purchase of the extended warranty service, our company will issue an extended warranty card to the customer to confirm the extended warranty period.

**Invalid warranty clause**

Equipment failure caused by the following reasons is not covered by the warranty:

- 1) The "warranty card" has not been sent to the distributor or Shenzhen SOFARSOLAR Co., LTD;
- 2) Without the consent of Shenzhen SOFARSOLAR Co., LTD to change equipment or replace parts;
- 3) Use unqualified materials to support Shenzhen SOFARSOLAR Co., LTD 's products, resulting in product failure;
- 4) Technicians who don't belong to Shenzhen SOFARSOLAR Co., LTD modify or attempt to repair and erase the product serial number or silk screen;
- 5) Incorrect installation, debugging and use methods;
- 6) Failure to comply with safety regulations (certification standards, etc.);
- 7) Damage caused by improper storage by dealers or end users;
- 8) Transportation damage (including scratches caused by internal packaging during transportation).Please claim directly from the transportation company or insurance company as soon as possible and obtain damage identification such as container/package unloading;
- 9) Failure to follow the product user manual, installation manual and maintenance guidelines;
- 10) Improper use or misuse of the device;
- 11) Poor ventilation of the device;
- 12) The product maintenance process does not follow relevant standards;
- 13) Failure or damage caused by natural disasters or other force (such as earthquake, lightning strike, fire, etc.)

Version 3.0



ENERGY TO POWER YOUR LIFE

**ADDRESS**

11/F., Gaoxinqi Technology Building,  
Xingdong Community,Xin'an Sub-district,  
Bao'an District, Shenzhen City,China

**EMAIL**

info@sofarsolar.com

**WEBSITE**

www.sofarsolar.com

SOFARSOLAR 

